

Grizzly *Industrial, Inc.*®

MODEL T25227
OSCILLATING MULTI-TOOL
OWNER'S MANUAL
(For models manufactured since 09/13)



COPYRIGHT © SEPTEMBER, 2013 BY GRIZZLY INDUSTRIAL, INC.
**WARNING: NO PORTION OF THIS MANUAL MAY BE REPRODUCED IN ANY SHAPE
OR FORM WITHOUT THE WRITTEN APPROVAL OF GRIZZLY INDUSTRIAL, INC.**
#DM15915 PRINTED IN CHINA



WARNING!

This manual provides critical safety instructions on the proper setup, operation, maintenance, and service of this machine/tool. Save this document, refer to it often, and use it to instruct other operators.

Failure to read, understand and follow the instructions in this manual may result in fire or serious personal injury—including amputation, electrocution, or death.

The owner of this machine/tool is solely responsible for its safe use. This responsibility includes but is not limited to proper installation in a safe environment, personnel training and usage authorization, proper inspection and maintenance, manual availability and comprehension, application of safety devices, cutting/sanding/grinding tool integrity, and the usage of personal protective equipment.

The manufacturer will not be held liable for injury or property damage from negligence, improper training, machine modifications or misuse.



WARNING!

Some dust created by power sanding, sawing, grinding, drilling, and other construction activities contains chemicals known to the State of California to cause cancer, birth defects or other reproductive harm. Some examples of these chemicals are:

- Lead from lead-based paints.
- Crystalline silica from bricks, cement and other masonry products.
- Arsenic and chromium from chemically-treated lumber.

Your risk from these exposures varies, depending on how often you do this type of work. To reduce your exposure to these chemicals: Work in a well ventilated area, and work with approved safety equipment, such as those dust masks that are specially designed to filter out microscopic particles.

Table of Contents

SECTION 1: SAFETY	2
Safety Instructions for Power Tools.....	2
Additional Safety for Oscillating Tools.....	4
SECTION 2: INTRODUCTION	5
Foreword.....	5
Specifications.....	5
SECTION 3: SETUP	6
Unpacking.....	6
Inventory	6
Assembly	7
Test Run	8
SECTION 4: OPERATIONS	9
Variable-Speed Dial.....	9
Multi-Tool Use.....	9
Sanding	10
Sawing/Cutting.....	11
Scraping.....	11
SECTION 5: ACCESSORIES	12
SECTION 6: MAINTENANCE	14
Schedule	14
Cleaning.....	14
SECTION 7: SERVICE	15
Troubleshooting	15
SECTION 8: PARTS	16
WARRANTY	17

SECTION 1: SAFETY

WARNING

For Your Own Safety Read Instruction Manual Before Operating This Power Tool

The purpose of safety symbols is to attract your attention to possible hazardous conditions. This manual uses a series of symbols and signal words which are intended to convey the level of importance of the safety messages. The progression of symbols is described below. Remember that safety messages by themselves do not eliminate danger and are not a substitute for proper accident prevention measures.

 **DANGER** Indicates an imminent hazardous situation which, if not avoided, **WILL** result in death or serious injury.

 **WARNING** Indicates a potentially hazardous situation which, if not avoided, **COULD** result in death or serious injury.

 **CAUTION** Indicates a potentially hazardous situation which, if not avoided, **MAY** result in minor or moderate injury. It may also be used to alert against unsafe practices.

NOTICE This symbol is used to alert the user to useful information about proper operation of the equipment.

WARNING

Safety Instructions for Power Tools

OWNER'S MANUAL. Read and understand this owner's manual **BEFORE** using machine.

TRAINED OPERATORS ONLY. Untrained operators have a higher risk of being hurt or killed. Only allow trained/supervised people to use this power tool. When tool is not being used, disconnect power, and store in out-of-reach location to prevent unauthorized use—especially around children. Make workshop kid proof!

DANGEROUS ENVIRONMENTS. Do not use tools in areas that are wet, cluttered, or have poor lighting. Operating tools in these areas greatly increases risk of accidents and injury.

MENTAL ALERTNESS REQUIRED. Full mental alertness is required for safe operation of power tools. Never operate under the influence of drugs or alcohol, when tired, or when distracted.

DISCONNECT POWER FIRST. Always disconnect tool from power supply **BEFORE** making adjustments, changing tooling, or servicing machine. This prevents an injury risk from unintended startup or contact with live electrical components.

EYE PROTECTION. Always wear ANSI-approved safety glasses or a face shield when operating or observing machinery to reduce the risk of eye injury or blindness from flying particles. Everyday eyeglasses are not approved safety glasses.

WARNING

ELECTRICAL SAFETY. Tool plug must match outlet. Double-insulated tools have a polarized plug (one blade is wider than the other), which must be plugged into a polarized outlet. Never modify plug. Do not use adapter for grounded tools. Use a ground fault circuit interrupter if operation is unavoidable in damp locations. Avoid touching grounded surfaces when operating tool.

WEARING PROPER APPAREL. Do not wear clothing, apparel or jewelry that can become entangled in moving parts. Always tie back or cover long hair. Wear non-slip footwear to avoid accidental slips, which could cause loss of workpiece control. Wear hard hat as needed.

HAZARDOUS DUST. Dust created while using tools may cause cancer, birth defects, or long-term respiratory damage. Be aware of dust hazards associated with each workpiece material, always wear a NIOSH-approved respirator, and connect tool to an appropriate dust collection device to reduce your risk.

HEARING PROTECTION. Always wear hearing protection when operating or observing loud machinery. Extended exposure to this noise without hearing protection can cause permanent hearing loss.

REMOVE ADJUSTING TOOLS. Never leave adjustment tools, chuck keys, wrenches, etc. in or on tool—especially near moving parts. Verify removal before starting!

INTENDED USAGE. Only use tool for its intended purpose. Never modify or alter tool for a purpose not intended by the manufacturer or serious injury or death may result!

AWKWARD POSITIONS. Keep proper footing and balance at all times when operating tool. Do not overreach! Avoid awkward hand positions that make tool control difficult or increase the risk of accidental injury.

SAFE HANDLING. Firmly grip tool. To avoid accidental firing, do not keep finger on switch or trigger while carrying.

FORCING TOOLS. Use right tool for job, and do not force it. It will do job safer and better at rate for which it was designed.

SECURING WORKPIECE. When required, use clamps or vises to secure workpiece. This protects hands and frees both of them to operate tool.

GUARDS & COVERS. Guards and covers reduce accidental contact with moving parts or flying debris. Ensure they are properly installed, undamaged, and working correctly.

CHILDREN & BYSTANDERS. Keep children and bystanders at a safe distance from the work area. Stop using tool if they become a distraction.

USE RECOMMENDED ACCESSORIES. Consult this manual or manufacturer for recommended accessories. Using improper accessories will increase risk of serious injury.

MAINTAIN WITH CARE. Keep cutting tool edges sharp and clean. Follow all maintenance instructions and lubrication schedules to keep tool in good working condition. A tool that is improperly maintained could malfunction, leading to serious personal injury or death. Only have tool serviced by qualified service-personnel using matching replacement parts.

CHECK DAMAGED PARTS. Regularly inspect tool for any condition that may affect safe operation. Immediately repair or replace damaged or mis-adjusted parts before operating tool.

MAINTAIN POWER CORDS. When disconnecting cord-connected tools from power, grab and pull the plug—NOT the cord. Carrying or pulling the cord may damage wires inside. Do not handle cord/plug with wet hands. Avoid cord damage by keeping it away from heated surfaces, high traffic areas, harsh chemicals, sharp edges, moving parts, and wet/damp locations. Damaged cords increase risk of electrocution.

UNATTENDED OPERATION. Never leave tool running while unattended. Turn tool **OFF** and ensure all moving parts completely stop before walking away.

EXPERIENCING DIFFICULTIES. If at any time you experience difficulties performing the intended operation, stop using the machine! Contact our Technical Support at (570) 546-9663.

WARNING

Additional Safety for Oscillating Tools

EYE PROTECTION. Sanding/cutting causes small particles to become airborne at a high rate of speed. **ALWAYS** wear safety glasses when using this tool.

CRACKED ACCESSORIES. Cracked tooling accessories may break and fly apart during operation or cause kickback. Inspect for damage before each use. Do not use damaged tooling accessories.

HAND/TOOL CONTACT. Oscillating tools have the capability of cutting or removing a lot of skin fast. Always maintain a firm grip on the tool. Wear close fitting work gloves whenever possible to avoid injury.

LUNG PROTECTION. Sanding/cutting produces hazardous dust, which may cause long-term respiratory problems if inhaled. Always wear a NIOSH approved dust mask or respirator when sanding or cutting.

HIDDEN PIPPING. Use a metal detector check for hidden gas and water lines prior to cutting into blind workspace such as walls or columns. Cutting into gas lines may cause explosion. Cutting into water lines may result in electrocution.

INSULATED GRIPS. Use insulated grip surfaces while operating oscillating tool to prevent shock or electrocution in case of contact with an electrical wire.

HAND PROTECTION. Wear gloves while operating multi-tool and changing accessories to protect against burning or cutting.

SPINDLE FLANGE. Always use the included mounting washer with the machine when mounting accessory tools. Other washers may not properly secure accessories and cause an accident.

FIRE/EXPLOSION HAZARD. Cutters/scrapers are capable of creating sparks, which can ignite flammable materials. Keep clear of flammable materials when using accessory tools.

TOOL STABILITY. Hold tool with both hands, and stabilize yourself against a fixed object. Using one hand without support increases risk of the tool grabbing workpiece and causing loss of grip, leading to serious personal injury.

RISK OF ELECTRIC SHOCK. Cutting into walls or workpieces with hidden wiring can result in shock or electrocution. Use a metal detector check for hidden gas and water lines prior to cutting into blind workspace such as walls or columns.

WET SANDING. Never wet sand with this multi-tool. Wet sanding with this multi-tool could result in electrocution.

OBSTRUCTIONS. Check for obstructions such as nails or screws in scraping or cutting path. Obstructions can cause kickback resulting in injury or damage to workpiece.

PROLONGED USE. Prolonged use of multi-tool can result in nerve damage from vibration. Wear protective gloves and take breaks using multi-tool.

SECTION 2: INTRODUCTION

Foreword

We are proud to offer this manual with your new oscillating multi-tool! We've made every effort to be exact with the instructions, specifications, drawings, and photographs of the multi-tool when writing this manual. However, sometimes we still make an occasional mistake.

Also, owing to our policy of continuous improvement, your multi-tool may not exactly match the manual. If you find this to be the case, and the difference between the manual and multi-tool leaves you in doubt, check our website for the latest manual update or call technical support for help.

For your convenience, we post all available manuals and manual updates for free on our website at www.grizzly.com. Any updates to your model of machine will be reflected in these documents as soon as they are complete.

Contact Info

We stand behind our machines. If you have any service questions, parts requests or general questions about the machine, please call or write us at the location listed below.

Grizzly Industrial, Inc.
1203 Lycoming Mall Circle
Muncy, PA 17756
Phone: (570) 546-9663
E-Mail: techsupport@grizzly.com

We want your feedback on this manual. If you can take the time, please email or write to us at the address below and tell us how we did:

Grizzly Industrial, Inc.
C/O Technical Documentation Manager
P.O. Box 2069
Bellingham, WA 98227-2069
Email: manuals@grizzly.com

Specifications

Power Requirement.....	120V, Single-Phase, 60 Hz
Full Load Current Rating.....	1.8A
Sanding Pad Size.....	3 $\frac{5}{8}$ "
Oscillations per Minute.....	15,000–22,000 OPM

SECTION 3: SETUP

Unpacking

This multi-tool was carefully packaged for safe transportation. Remove the packaging materials from around your machine and inspect it. If you discover any damage, *please immediately call Customer Service at (570) 546-9663 for advice.*

Save the containers and all packing materials for possible inspection by the carrier or its agent. Otherwise, filing a freight claim can be difficult.

When you are completely satisfied with the condition of your shipment, inventory the contents.

If any non-proprietary parts are missing (e.g., a nut or a washer), we will gladly replace them; or for the sake of expediency, replacements can be obtained at your local hardware store.

WARNING

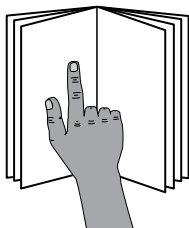

This tool presents serious injury hazards to untrained users. Read through entire manual to become familiar with the controls and operations before using!

Inventory

Model T25227 Inventory	Qty
A. Carrying Case.....	1
B. Oscillating Tool	1
C. Hex Wrench 6mm.....	1
D. Mounting Washers 26 & 18mm ...	1 Ea
E. M8-1.25 x 12mm Cap Screw	1

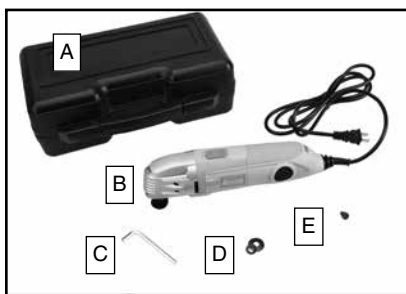

Figure 1. Tool inventory.

F. White Sanding Pads	5
G. Red Sanding Pads.....	5
H. Wood and Metal Saw Blades	1 Ea
I. Sanding Attachment.....	1
J. Scraper	1
K. Radial Saw Blade	1

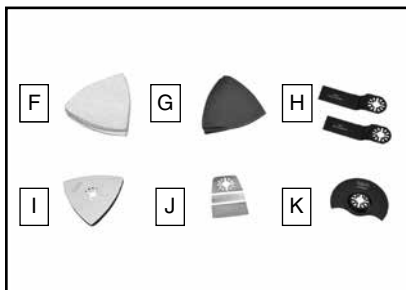

Figure 2. Accessories inventory.

Assembly

The T25227 Oscillating Multi-Tool comes with several accessory tools for a variety of jobs. With the groove and rivet design, each accessory tool can be mounted in 12 different directions. Choose the most effective direction to complete the job considering stability and safety.

Select the right accessory tool for the job. Prior to attaching, carefully inspect the accessory for cracks, chips or other damage. **DO NOT** use tools that have been damaged.

To install tool accessories:

1. **DISCONNECT TOOL FROM POWER!**
2. Lay the multi-tool tool on a flat surface with the tool flange facing upward (see **Figure 3**).

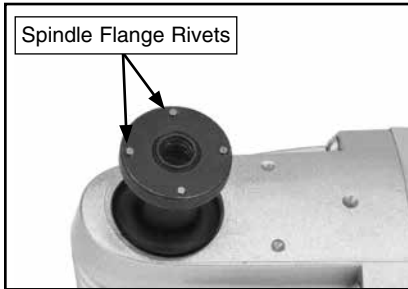

Figure 3. Flange rivets for aligning accessory grooves.

3. Remove dust and debris from the cap screw, flanges, and accessories.
4. Place the accessory of choice onto the tool flange at the desired direction, aligning the rivets of the tool flange with the grooves of the accessory (see **Figure 3**).

5. Put the accessory washer over the accessory tool (small for the sanding accessory or large for all other accessories), aligning the washer hole with the flange hole. Make sure the convex side of the washer is facing down.
6. Using the provided 6mm hex wrench, firmly secure the accessory with the cap screw (see **Figures 4-5**).

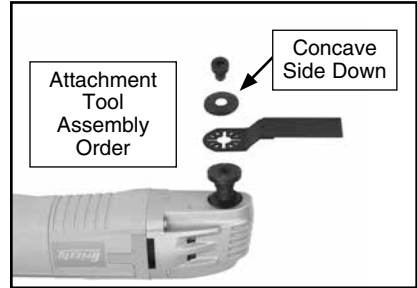

Figure 4. Attachment tool assembly order.

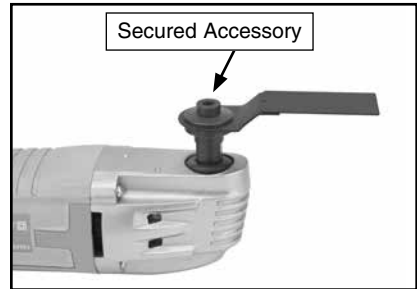

Figure 5. Accessory secured to tool.



Test Run

Prior to using the multi-tool for the first time, perform this test run procedure to ensure it functions properly.

To test run multi-tool:

1. Connect the tool to power.
2. While firmly holding multi-tool tool, push the switch forward to turn it **ON**.
3. Using your free hand, rotate the variable-speed dial to ensure speed increases/decreases as the dial is moved.
 - If operating correctly, the multi-tool will continue running when the switch is pressed forward, and the speed will increase when the speed dial is rotated towards 6.
 - If the multi-tool does not start and continue to run when the switch is pressed forward, or the speed does not increase/decrease when the speed dial is rotated, then the multi-tool is not working properly. DISCONNECT it from power and contact Tech Support to resolve the problem before using it any further.

SECTION 4: OPERATIONS

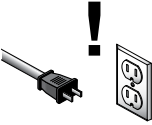
 WARNING	
	LUNG/EYE INJURY HAZARD! Wear a respirator and safety glasses when using this tool.
	ACCIDENTAL START HAZARD! Disconnect power before servicing or changing accessories.

Variable-Speed Dial

The variable-speed dial adjusts the multi-tool between 15,000 and 22,000 oscillations per minute (OPM). The speed dial can be set before starting the tool or while in use.

Multi-Tool Use

The purpose of this overview is to provide the novice machine operator with a basic understanding of how the machine is used during operation, so the machine controls/components discussed later in this manual are easier to understand.

Due to the generic nature of this overview, it is not intended to be an instructional guide. To learn more about specific operations, read this entire manual and seek additional training from experienced machine operators, and do additional research outside of this manual by reading "how-to" books, trade magazines, or websites.

To perform a typical operation:

1. DISCONNECT MULTI-TOOL FROM POWER!
2. Install appropriate accessory tool for the operation (refer to **Assembly** section on **Page 12**).
3. Put on safety glasses and a respirator.
4. Connect the multi-tool to power.
5. Firmly hold multi-tool, turn **ON**, and adjust speed dial as necessary for job.
6. While maintaining a balanced position, complete the operation with both hand on the multi-tool to ensure proper control.

— If working on a small workpiece that could shift during operation and cause a loss of control, secure it with clamps or a vise.

— If working on a wall or other object that may have wiring, pipes, or other flammable pressurized material inside, inspect it carefully to ensure you know what is on the other side of the cut.

Sanding

Use the 3⁵/₈" triangular platen accessory and either a red or white sanding pad.

The sanding pads use a hook-and-loop system, which provides easy attachment and removal. To install the sanding pad, align the pad with the platen and press on firmly (see **Figure 6**).

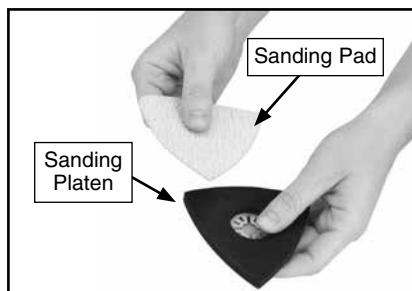

Figure 6. Attaching sanding pad.

Tips for sanding:

- Practice on similar scrap material and inspect results before working on intended workpiece.
- Adjust speed according to material type. Using high speed removes material quickly and can result in non-uniform surfaces.
- Use sweeping side-to-side motions with uniform pressure and speed.
- Check sanding pads for wear and dust accumulation between jobs. Clean or replace sanding pads as necessary.

Sawing/Cutting

WARNING

Always inspect back/inside of material to be cut for electrical wiring, pipes, or other flammable or pressurized material. Failure to do so could result in serious injury or death.

This multi-tool comes with wood and metal saw blades and a radial saw blade for cutting a variety of materials.

Tips for sawing/cutting:

- Practice on similar scrap material and inspect results before working on intended workpiece.
- Use light-to-medium pressure when cutting to prevent burning workpiece or damaging multi-tool motor from overloading.
- Do not use excessive force when making cuts. If blades do not cut through material with light-to-moderate pressure, select an appropriate blade for the material or replace the blade if it has become dull.
- For best results, mark the cutting path with a pencil, crayon, or chalk line before beginning the cut.

Scraping

This multi-tool comes with a scraper for scraping off fixed adhesives.

Tips for scraping:

- Use light-to-medium pressure to avoid breaking or gouging workpiece.
- Using excessive force will decrease the life of the multi-tool motor.
- Keep scraper parallel with the workpiece.

SECTION 5: ACCESSORIES

T25148—1 $\frac{1}{8}$ " Flush Cut Saw Blade

Flush-Cut Saw Blades are ideal for wood and metal and feature a fine tooth count for smooth cuts.



Figure 7. Flush-cut saw blade.

T25151—3 $\frac{7}{16}$ " HSS Radial Saw Blade

Constructed of high speed steel (HSS). Cuts wood and metal, or can be used as a radial saw blade for flush cutting.



Figure 8. Radial saw blade.

T25159—3 $\frac{5}{8}$ " Sanding Pad

Sanding Pad features micro-hook and loop fastening system for quick and easy sanding sheet changes.



Figure 9. Sanding pad.

T25160—3 $\frac{1}{8}$ " Diamond Coated Rasp

These rasps are ideal for removing mortar or tile adhesive when getting rid of damaged tile as well as removing carpet adhesive from hard surfaces. Also for rough grinding wood, stone, and concrete.

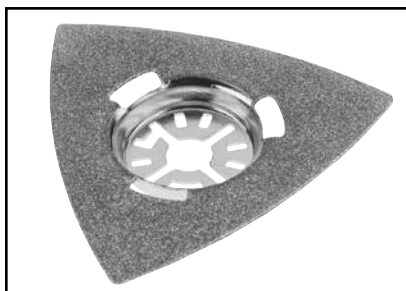

Figure 10. Diamond coated rasp.

Call 1-800-523-4777 To Order

T25150—Carbide Grit Saw Blade

This 2⁹/₁₆" blade offers a carbide grit edge. Cuts tile, plaster, porous concrete, or rough grinds wood, stone, and concrete.

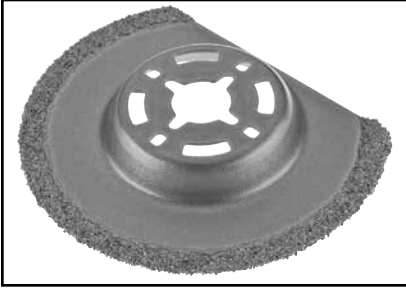

Figure 11. Carbide grit saw blade.

T25158—2⁹/₁₆" Grout/Mortar Remover

Grout and Mortar Remover combines a segment blade with a triangle blade in a drop-shape design. Can be used to rout out damaged tile and rasp away mortar or tile adhesive without changing the tool.

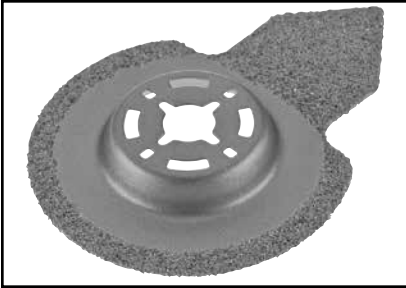

Figure 12. Grout and mortar remover.

T25139—2¹/₁₆" Pushcut Saw Blade

The Precision Push-Cut Wood Blades have CRV hardened ground and side set teeth for precise, clean, and quick cutting.

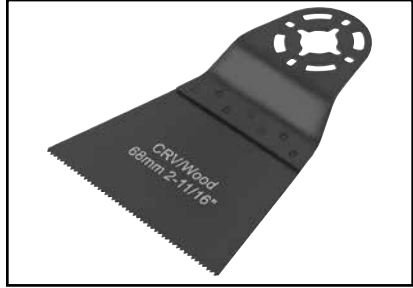

Figure 13. Pushcut saw blade.

T25156 2" Flexible Scraper

Flexible Scrapers are ideal for removing soft adhesives, paint residue, and silicone caulk.



Figure 14. Flexible scraper.

SECTION 6: MAINTENANCE

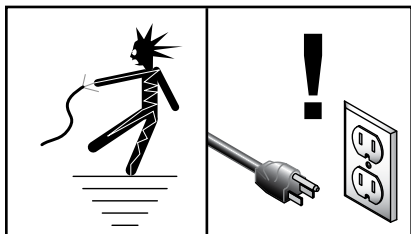

⚠️ WARNING

Always **DISCONNECT POWER** before servicing, adjusting, or doing maintenance to reduce the risk of accidental injury or electrocution.

⚠️ WARNING

Never submerge tool in liquid or clean with flammable solvents. Electrocution or fire may result, causing serious injury or death.

Schedule

For optimum performance from your multi-tool, follow this maintenance schedule and refer to any specific instructions given in this section.

Daily Check:

- Loose mounting bolts.
- Worn switch.
- Worn or damaged cord.
- Any other unsafe condition.

Cleaning

Cleaning the Model T25227 is relatively easy and should be done daily to prevent build up of dust and resins.

Use an air hose or vacuum to remove excess wood chips and dust from the ventilation openings (see **Figure 15**).

Use a dry rag to wipe off the remaining dust and debris from the tool flange and any accessories used.

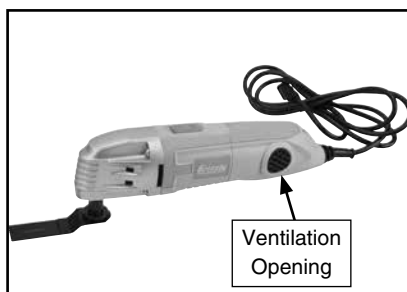

Figure 15. Ventilation opening.

SECTION 7: SERVICE

Troubleshooting

Symptom	Possible Cause	Solution
Multi-tool does not start.	<ol style="list-style-type: none">1. Power supply circuit breaker tripped or blown.2. ON/OFF switch at fault.3. Motor at fault.4. Motor brushes at fault.	<ol style="list-style-type: none">1. Ensure circuit is sized correctly and free of shorts. Reset circuit breaker or replace fuse.2. Replace switch.3. Test/repair/replace motor.4. Remove/replace brushes.
Poor workpiece finish results.	<ol style="list-style-type: none">1. Oscillation speed too high resulting in workpiece burn marks when cutting.2. Bad angle or too much force resulting in gouges or ripping of workpiece when scraping.3. Uneven finished surface when sanding.4. Incorrect blade or accessory for job.	<ol style="list-style-type: none">1. Reduce oscillation speed.2. Reduce pressure used for scraping and keep tool parallel with workpiece.3. Reduce the speed and maintain uniform pressure with long sweeping motions.4. Use correct accessory for task.
Multi-tool chatters and/or does not cut straight.	<ol style="list-style-type: none">1. Accessory not secured properly.	<ol style="list-style-type: none">1. Re-align accessory grooves with rivets on spindle flange and secure.
Multi-tool performing slower and/or finished product results diminishing.	<ol style="list-style-type: none">1. Blade has become dull.2. Sanding pad has worn thin.3. Failing motor brushes.	<ol style="list-style-type: none">1. Replace blade.2. Replace sanding pad.3. Remove/replace brushes.

SECTION 8: PARTS

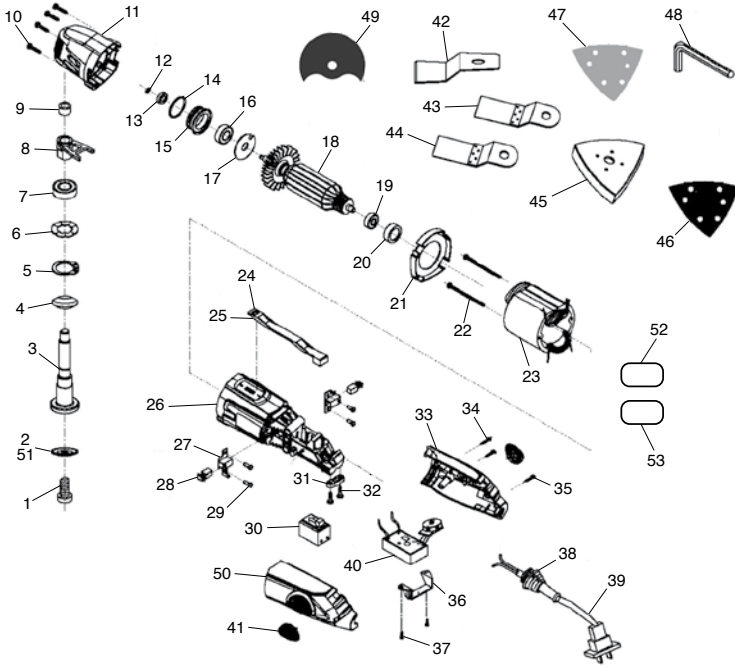

REF PART #	DESCRIPTION
1	PT25227001 CAP SCREW M8-1.25 X 12
2	PT25227002 MOUNTING WASHER 26MM
3	PT25227003 SPINDLE
4	PT25227004 BUSHING (RUBBER)
5	PT25227005 EXT RETAINING RING 26MM
6	PT25227006 SPLINE LOCK WASHER
7	PT25227007 BALL BEARING 6000ZZ
8	PT25227008 OSCILLATING FORK
9	PT25227009 BUSHING (BRONZE)
10	PT25227010 PHLP HD SCR M4-.7 X 30
11	PT25227011 FRONT HOUSING
12	PT25227012 EXT RETAINING RING 5MM
13	PT25227013 BALL BEARING 625ZZ
14	PT25227014 GASKET
15	PT25227015 BEARING SEAT
16	PT25227016 BALL BEARING 608ZZ
17	PT25227017 OSCILLATING RING
18	PT25227018 ARMATURE
19	PT25227019 BALL BEARING 607ZZ
20	PT25227020 BEARING SEAT (RUBBER)
21	PT25227021 STATOR MOUNT
22	PT25227022 PHLP HD SCR M4-.7 X 50
23	PT25227023 STATOR
24	PT25227024 BRACE
25	PT25227025 CONNECTION LINK
26	PT25227026 MIDDLE HOUSING
27	PT25227027 MOTOR BRUSH HOLDER

REF PART #	DESCRIPTION
28	PT25227028 MOTOR CARBON BRUSH 2-PC SET
29	PT25227029 RIVET
30	PT25227030 ON/OFF SWITCH
31	PT25227031 CORD CLIP
32	PT25227032 PHLP HD SCR M4-.7 X 14
33	PT25227033 REAR HOUSING (RH)
34	PT25227034 PHLP HD SCR M4-.7 X 25
35	PT25227035 PHLP HD SCR M4-.7 X 22
36	PT25227036 RHEOSTAT BRACKET
37	PT25227037 PHLP HD SCR M3-.5 X 8
38	PT25227038 CORD STRAIN RELIEF
39	PT25227039 POWER CORD 18G 2C 48" 1-15P
40	PT25227040 RHEOSTAT ASSEMBLY
41	PT25227041 VENT SCREEN
42	PT25227042 SCRAPER TOOL
43	PT25227043 SAW BLADE FOR WOOD
44	PT25227044 SAW BLADE FOR METAL
45	PT25227045 SANDING PLATEN ATTACHMENT
46	PT25227046 RED SANDING PAD
47	PT25227047 WHITE SANDING PAD
48	PT25227048 HEX WRENCH 6MM
49	PT25227049 RADIAL SAW BLADE
50	PT25227050 REAR HOUSING (LH)
51	PT25227051 MOUNTING WASHER 18MM
52	PT25227052 ID LABEL
53	PT25227053 GRIZZLY LOGO LABEL

WARRANTY

Grizzly Industrial, Inc. warrants every product it sells for a period of **1 year** to the original purchaser from the date of purchase. This warranty does not apply to defects due directly or indirectly to misuse, abuse, negligence, accidents, repairs or alterations or lack of maintenance. This is Grizzly's sole written warranty and any and all warranties that may be implied by law, including any merchantability or fitness, for any particular purpose, are hereby limited to the duration of this written warranty. We do not warrant or represent that the merchandise complies with the provisions of any law or acts unless the manufacturer so warrants. In no event shall Grizzly's liability under this warranty exceed the purchase price paid for the product and any legal actions brought against Grizzly shall be tried in the State of Washington, County of Whatcom.

We shall in no event be liable for death, injuries to persons or property or for incidental, contingent, special, or consequential damages arising from the use of our products.

To take advantage of this warranty, contact us by mail or phone and give us all the details. We will then issue you a "Return Number," which must be clearly posted on the outside as well as the inside of the carton. We will not accept any item back without this number. Proof of purchase must accompany the merchandise.

The manufacturers reserve the right to change specifications at any time because they constantly strive to achieve better quality equipment. We make every effort to ensure that our products meet high quality and durability standards and we hope you never need to use this warranty.

Please feel free to write or call us if you have any questions about the machine or the manual.

Thank you again for your business and continued support. We hope to serve you again soon.

grizzly.com[®]
TOOL WEBSITE

Buy Direct and Save with Grizzly[®] – Trusted, Proven and a Great Value!
~Since 1983~

*Visit Our Website Today For
Current Specials!*

**ORDER
24 HOURS A DAY!
1-800-523-4777**

